



Flow switch

QVE1901

for liquids in piping DN 20...200.

-
- **Contact load / switching capacity:** max. AC 230 V, 1 A, 26 VA
max. DC 48 V, 1 A, 20 W
 - **Nominal pressure PN25**
 - **Manual setting of contact type (NO / NC)**
 - **Housing IP 65 / safety class II**
 - **Maintenance free**

Mode of operation

Flow monitor of liquid medium in HVAC plants in hydraulic systems, in particular, refrigeration, heat pump and heating plants, e.g. for evaporators, boilers, heat exchangers, etc.

Ordering

When ordering, please provide the name and product number:
Flow switch **QVE1901**

Mechanical design

The device records the flow of monitored medium via a paddle system (1), which has a permanent magnet (2) attached at its upper end. A reed contact (3) is positioned outside the flow above this magnet. A second magnet (4) with opposite polarity is used to create a reset force. The paddle system moves once it comes into contact with the monitored flow. The magnet (2) changes its position to the reed contact (3). The contact opens/closes depending on the contact type. As soon as the flow is interrupted, the paddle returns to its original position and the reed contact opens/closes depending on the contact type. (See "Adjusting the switching unit" on page 5)

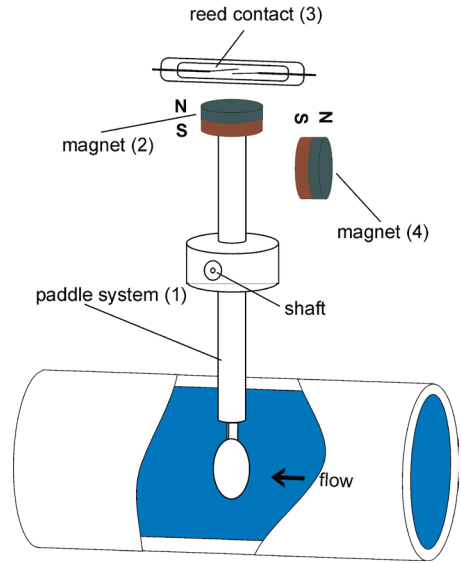

Switching value table for water at 20 °C

DN	Q _{max} (m ³ /h)	(m ³ /h) Factory setting		(m ³ /h)	
		≤	≥	≤	≥
20	4	≤0.9	≥1.1	≤0.9	≥1.1
25	5	≤1.1	≥1.3	≤1.1	≥1.3
32	8	≤1.6	≥1.9	≤1.6	≥1.9
40	10	≤1.8	≥2.1	≤1.8	≥2.1
50	14	≤2.4	≥2.7	≤2.4	≥2.7
80	30	≤4.7	≥5.1	≤4.7	≥5.1
100	40	≤5.8	≥6.4	≤5.9	≥6.4
150	100	≤14.2	≥15.5	≤14.2	≥15.5
200	180	≤29.0	≥30.0	≤29.0	≥30.0

Engineering notes

- On site, a T-junction 1/2" thread per EN DIN 10241 required (steel fittings with threads) and EN DIN 10242 (threaded fitting from malleable casting) required
- All dimensions and data provided in the table of switching values are based on water at 20 °C, the use of T-junctions and **horizontal** piping
- Before and after the mounting location of the flow switch, a smoothing path of at least 10 times or 5 times respectively the nominal pipe diameter required

Flow switch installation

Mechanical installation General installation instructions

- When choosing the installation site, ensure that the specified limit values (see "Technical Data") are not exceeded.
- Select suitable measures to prevent the medium from freezing. If the flow switch is to be used in ambient temperatures of $<4^{\circ}\text{C}$, do not carry out any operation beforehand using pure water. Residual water in the flow switch can result in frost damage.
- First, clean the pipe system where the flow switch is installed and remove any magnetic particles, e.g. welding residue.
- The smoothing section in front of and behind the flow switch must be at least 10 times or 5 times respectively.
- The nominal installation position of the flow switch is "upright standing position" in horizontal pipework.
- The switches should only be installed in a vertical position; deviation max. of 45° .
- Please make sure that there are no external magnetic fields in the immediate vicinity of the flow switch, since these can impair device operation.
- There is an arrow on the flow switch. Ensure during installation that the arrow is parallel with the pipe shaft and is facing in the flow direction.

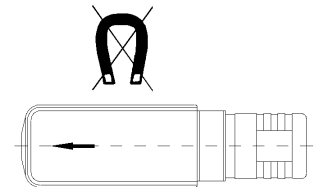
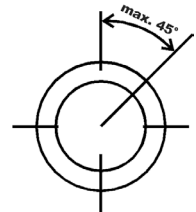

- The brass connecting nut $G\frac{3}{4}$ has a tightening torque of 25...30 Nm.

DN20...200

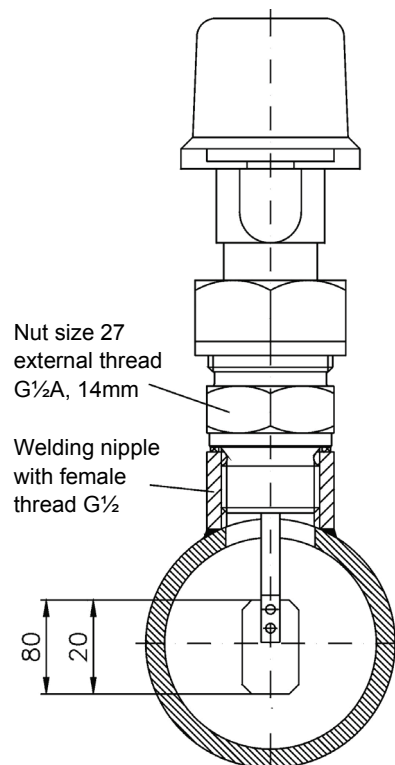

Installation notes

- Observe all local regulations from the electrical utilities or waterworks as applicable
- Allow for an extra loop of the connecting cable to ensure the switching value can be adjusted

Electrical connections

Warning



• **Danger of death due to electrical voltage!**

Work on electrical installations may only be carried out by qualified electricians or by instructed persons working under the guidance and supervision of a qualified electrician, in accordance with the electrical regulations.

Always de-energize the system before connecting the wires of the mains cable.

- **CAUTION:** Ensure that the maximum electrical contact load specified on the type plate is never exceeded; otherwise the reed contact integrated in the switching unit will be damaged.
Inductive loads impair switching capacity. Please ask the manufacturer for information on protective circuits.

Elbow plug connector EN 175301-803-A

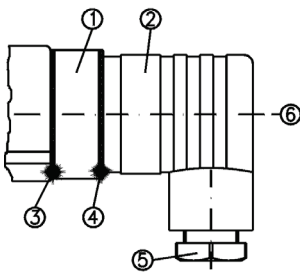

Fig. 1

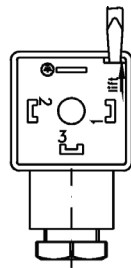

Fig. 2

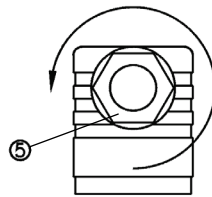

Fig. 3

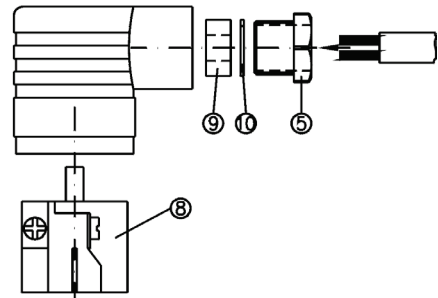
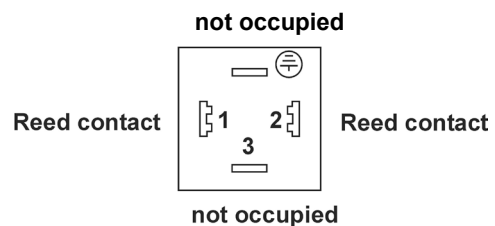
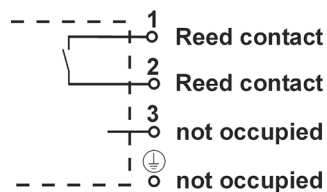

Fig. 4

- Loosen the central screw (pos. 6) M3x35 and disconnect the junction box EN 175301-803-A (pos. 2) from the connector (pos. 1, Fig. 1).
- Use a screwdriver or similar tool to press out the core (pos. 8) of the junction box (Fig. 2).
- Loosen the screw connection PG 9 (pos. 5, Fig. 3).
- Feed the connecting cable into the junction box via the screw connection (pos. 5), the clamping ring (pos. 10) and the rubber insert (pos. 9) and subsequently connect the wires as displayed in the connection diagram (see Fig. 4).



- Press the core (pos. 8) until it locks into position in the junction box (pos. 2).
- Tighten the cable gland PG 9 (pos. 5).
- Place the junction box (pos. 2) on the connector (pos. 1) and retighten the central screw (pos. 6).

- To guarantee the protection class IP 65 per EN 60529, the applied connecting cable has to have a sheathing diameter of between 4.5 and 7 mm.
- Furthermore, ensure that all the connector seals (pos. 3, 4 and 9) have been correctly inserted.

Adjust switching unit

Standard contact

The switching unit of the control switch enables 2 contact types:

1. Make contact (normally open): "RED" arrow on the switching unit
2. Break contact (normally closed): "WHITE" arrow on the switching unit

The following table explains the two contact types:

Contact type	Setting	Flow rate	Electric contact
Make contact (NO)	RED arrow	increasing	closing
		decreasing	opening
Break contact (NC)	WHITE or BLUE arrow	increasing	opening
		decreasing	closing

Unless otherwise agreed to with the customer, the switching unit is factory set to make contact, i.e. opens if the set switching point is exceeded.

- In order to adjust the switching unit, open the cover of the switching head

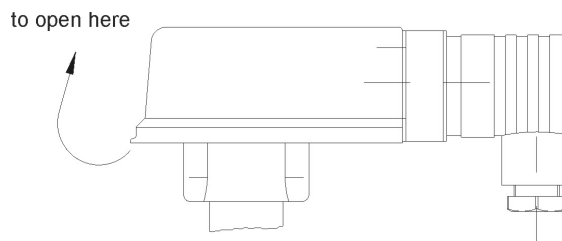

- Subsequently loosen the locking screw (2.5 hexagon socket screw) and position the switching unit until the red or white arrow are visible at the entry of the switching contact guide for a desired make contact or break contact respectively.
- You can use the arrow length to make fine adjustments to the switching point:
Adjust to the arrowhead means: Switching point is at a lower flow rate.
Adjust to the arrow end: Switching point is at a higher flow rate.
- Carefully retighten the locking screw.
- We recommend you to use lacquer/thread locker to secure the locking screw of the switching unit after carrying out individual adjustments.
- Close the cover until it locks into place.

make contact (red arrow)

break contact (white arrow)

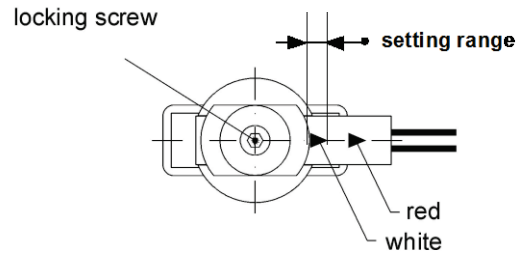
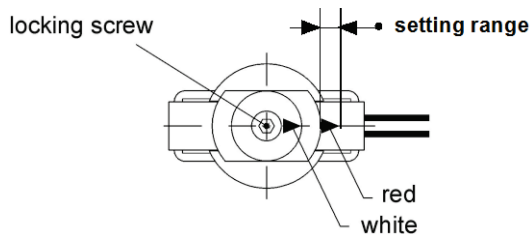

The switching unit does not need to be adjusted when the customer requests a factory set switching point.

Maintenance and repair

The flow switch is maintenance-free and cannot be repaired by the user. In the unlikely event of a defect, the device has to be returned to the manufacturer for repair.

Disposal



The device is considered an electronic device for disposal in accordance with the European Guidelines and may not be disposed of as domestic garbage.

- Dispose of the device via the channels provided for this purpose.
- Comply with all local and currently applicable laws and regulations.

Technical data

Functional data	Field of use	All liquids (not suitable for ammonia)
	Suitable media	DN 20...200
Degree of protection	Piping diameter	Reed contact
	Type of switch	AC 230 V, 1 A / DC 48 V, 1 A
	Max. contact rating	AC 26 VA / DC 20 W
	Max. switching capacity	Fuse slow max. 10 A
	External supply line protection (EU)	or Circuit breaker max. 13 A Characteristic B, C, D according to or Power source with current limitation of max. 10 A
	Switching point adjustment	manual, supplied with minimum switch-off value
	Tolerance of switching point ranges in the table	±15 %
	Setting range	See switching value table
	Medium temp. (medium cannot freeze)	-20...110 °C
	Nominal pressure	PN 25
Environmental conditions	Protection class	III according to EN 60730-1
	Housing	IP65 according to EN 60529
Environmental conditions	General environmental conditions	
	Operation and storage	-20...80 °C
	Ambient humidity	<95 % r.h.

Standards, directives, and approvals	Product standard	EN 60204-1 Safety of machinery - Electrical equipment of machines CM1T1594xx *) Eurasia Conformity
Environmental compatibility	EU Conformity (CE) EAC Conformity	The product environmental declaration CM1E1594*) contains data on environmentally compatible product design and assessments (RoHS compliance, materials composition, packaging, environmental benefit, disposal).
Materials / Color	Housing Screw-in body G½"	Polyamide, black Brass
Weight	excl. packaging	0.31 kg

*) The documents can be downloaded from <http://siemens.com/bt/download>.

Dimensions

Cutting the paddle

DN	L_3 (mm)
20	40 ±1
25	46 ±1
32	51 ±1
40	61 ±1
50	71 ±1
80	91 ±1
100	111 ±1
150	111 ±1
200	111 ±1

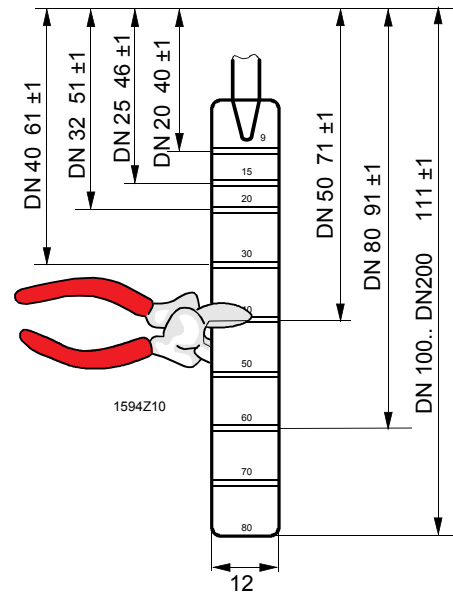

Flow switch

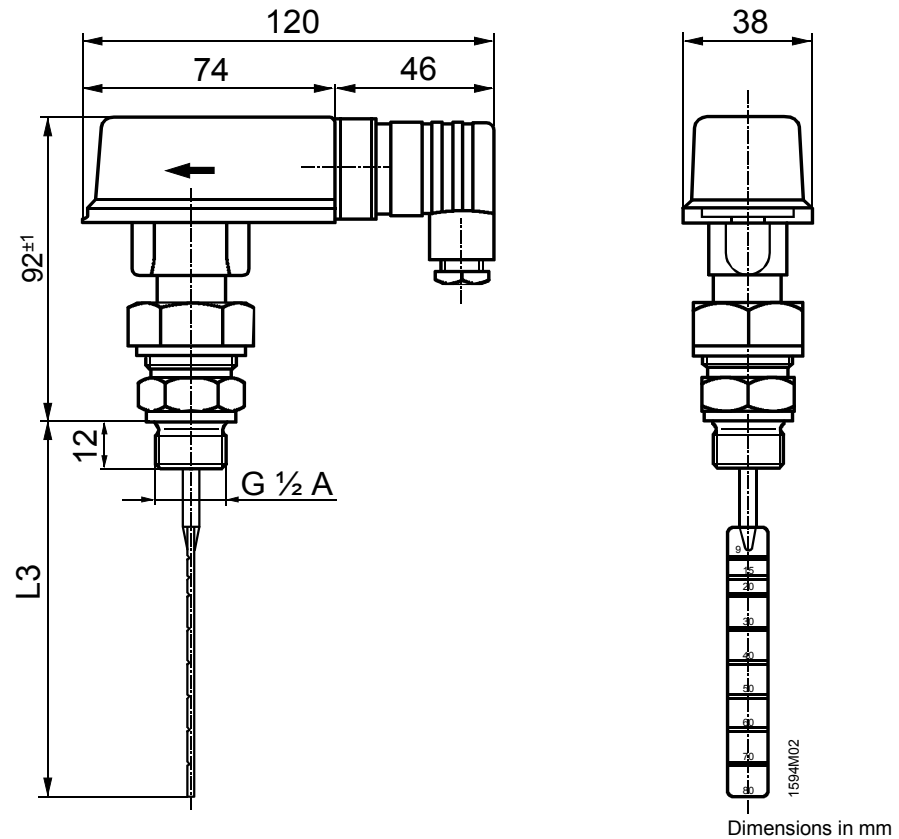

Published by:
 Siemens Switzerland Ltd.
 Building Technologies Division
 International Headquarters
 Theilerstrasse 1a
 CH-6300 Zug
 Switzerland
 Tel. +41 58-724 24 24
www.siemens.com/buildingtechnologies

© Siemens Switzerland Ltd 2007
 Delivery and technical specifications subject to change