



Room temperature controller with large LCD

RDH10

Non-programmable, for heating or cooling systems

-
- Large LCD
 - Battery-powered: 2 x alkaline batteries type AA, 1.5 V

Use

The RDH10 is used to control the room temperature in heating or cooling systems.

Typical applications:

- Homes
- Residential buildings
- Schools
- Offices

The controller is used together with the following equipment:

- Thermal valves or zone valves
- Combi boilers
- Gas or oil burners
- Fans
- Pumps

Functions

The controller acquires the room temperature with its integrated sensor.

Function diagram

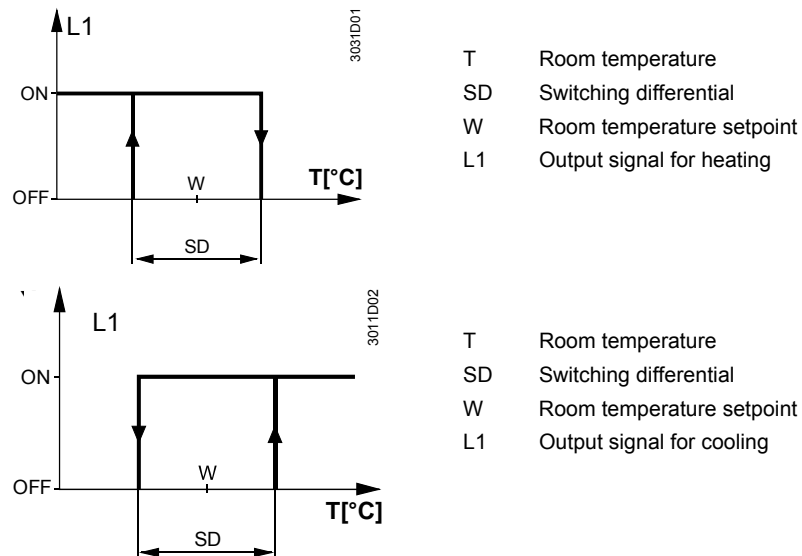

Temperature sensor

The RDH10 provides control of the room temperature only.

Display

The digital display shows the actual room temperature and the Comfort temperature setpoint. When the heating output is active, the triangle symbol appears.



Backup

When taking out the batteries, the setpoints and the information required for operating mode changeover are retained for maximum 2 minutes.

Ordering

When ordering, please give name and product number: Room temperature controller RDH10.

Valves and actuators are to be ordered as separate items.

Equipment combinations

Type of unit	Product number	Data sheet
Electromotoric actuator	SFA21...	4863
Electrothermal actuator (for radiator valves)	STA21...	4877
Electrothermal actuator (for small valves 2.5 mm)	STP21...	4878
2- or 3-port zone valve	MXI/MVI421...	4867
Electromotoric actuator for zone valves V..146..	SUA21	4830
Electric actuator	SUA11/22	4832
Air damper actuator	GDB...	4624
Air damper actuator	GSD/GQD...	4606
Air damper actuator	GXD...	4622

The unit consists of 3 parts:

- Plastic housing with digital display accommodating the electronics, operating elements and built-in room temperature sensor
- Baseplate (mounting base)
- Removable battery compartment

The housing engages in the baseplate and snaps on. The baseplate carries the screw terminals. There is a reset button on the rear of the unit.

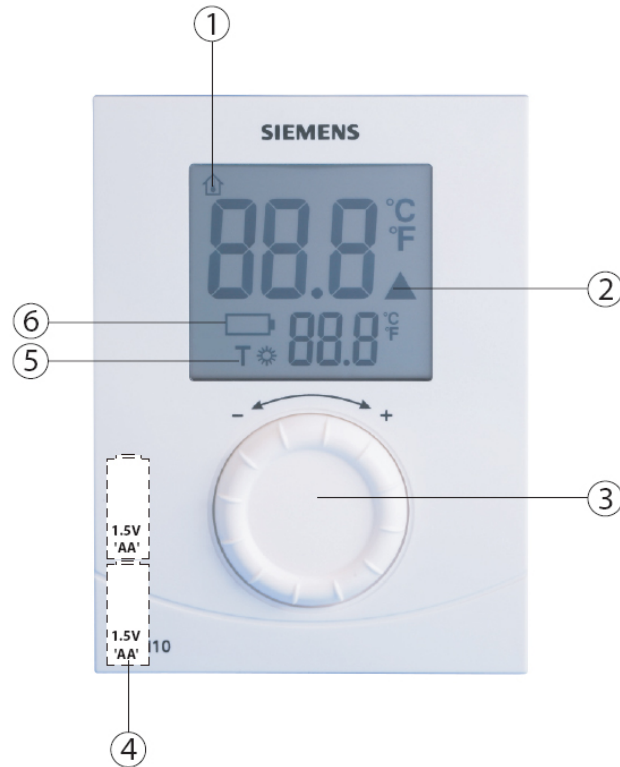

Key

- 1 Display of the room temperature in °C
- 2 Indicates a request for heat
- 3 Temperature setting knob
- 4 Battery compartment
- 5 Comfort temperature setpoint
- 6 Indicates low battery power; replace batteries

Notes

Mount the room temperature controller in a location where the air temperature can be acquired as accurately as possible without getting adversely affected by direct solar radiation or other heat or refrigeration sources.

Mounting height is about 1.5 m above the floor.

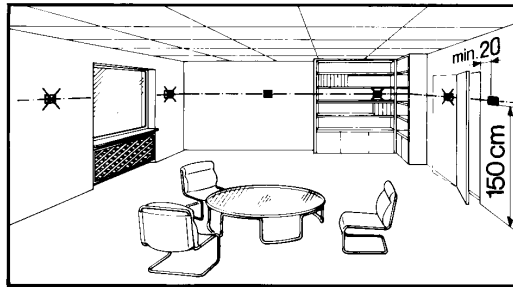

The unit can be fitted to a recessed conduit box.

Mounting, installation and commissioning

When mounting the unit, fix the baseplate first. Then, make the electrical connections and fit and secure the controller (also refer to the separate mounting instructions).

Mount the controller on a flat wall and in compliance with local regulations.

If there are thermostatic radiator valves in the reference room, set them to their fully open position.

Maintenance

The controller is maintenance-free.



Change of batteries

If the battery symbol  appears, the batteries are almost exhausted and must be replaced.

Reset

To reset, press the reset button on the rear of the unit. All individual settings are then reset to their default values.

Technical data

Power supply	Operating voltage	DC 3 V (2 x 1.5 V AA alkaline batteries)
	Battery life	>1 year (with AA alkaline batteries)
Sensor inputs	Internal: Thermistor	10 kΩ ± 1% at 25 °C
Outputs	Relay contacts	
	Switching voltage	Max. AC 250 V Min. AC 24 V
⚠ Switching outputs (LX, L1, L2)	Switching current	Max. 5 A res., 2 A ind.
	At AC 250 V	Min. 200 mA
	Contact life at AC 250 V	Guide value:
	At 5 A res.	1 x 10 ⁵ cycles
	Insulating strength	
	Between relay contacts and coil	AC 3,750 V
	Between relay contacts (same pole)	AC 1,000 V
Operational data	Switching differential SD	1 K
	Setpoint setting range	5...30 °C
	Factory setting comfort setpoint	20 °C
	Resolution of settings and displays	
	Temperature setpoint	0.5 °C
	Display of actual temperature value	0.5 °C
Electrical connections	Connection terminals (via baseplate)	Screw terminals
	For solid wires	2 x 1.5 mm ²
	For stranded wires	1 x 2.5 mm ² (min. 0.5 mm ²)
Environmental conditions	Operation	IEC 721-3-3
	Climatic conditions	Class 3K5
	Temperature	0...+40 °C
	Humidity	<90% r.h.
	Transport	IEC 721-3-2
	Climatic conditions	Class 2K3
	Temperature	-25...+60 °C
	Humidity	<95% r.h.
	Mechanical conditions	Class 2M2
	Storage	IEC 721-3-1
	Climatic conditions	Class 1K3
	Temperature	-10...+60 °C
	Humidity	<90% r.h.
Standards	 conformity to	
	EMC directive	2004/108/EC
	Low-voltage directive	2006/95/EC
	 C-tick conformity to	
	Test standards and requirements	EN 61000-6-3, AS/NZS 4251.1: 1999
	Product safety	
	Automatic electrical controls for household and similar use	EN 60730-1 and EN 60730-2-9
	Information technology equipment-Safety-General Requirements	EN 60950-1
	Generic standards-Compliance to lower power electronic apparatus	EN 50371-1
	Safety class	II as per EN 60730
	Pollution degree	2
	Degree of protection of housing	IP20
General	Weight (incl. packaging)	
	RDH10	340 g
	Color of housing front	Signal-white RAL 9003
	Housing material	ABS (LCD lens: PC)

Connection diagram

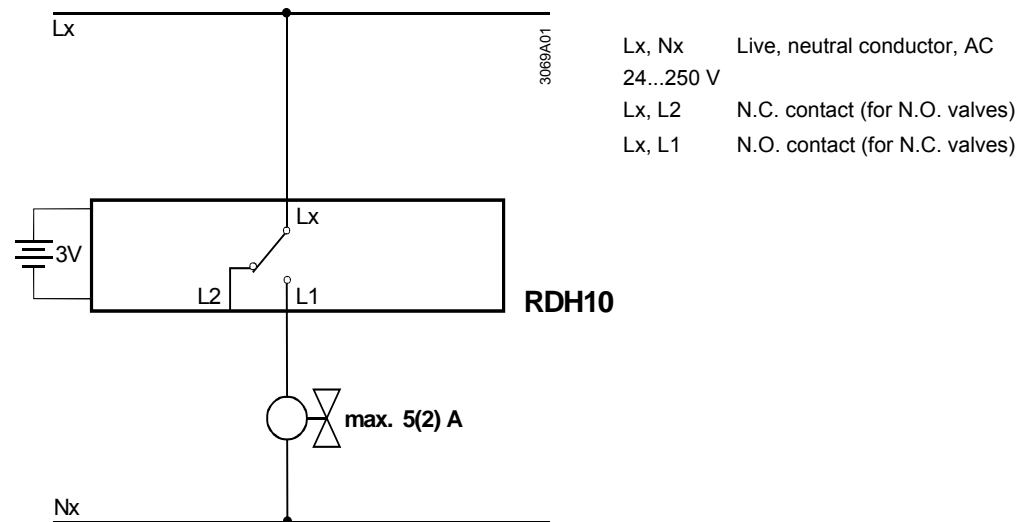

Application examples

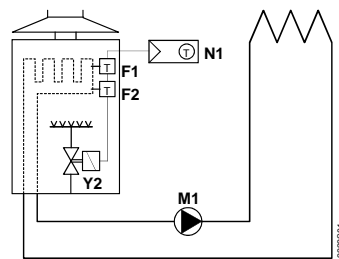

Room temperature controller with direct control of a gas-fired wall-hung boiler

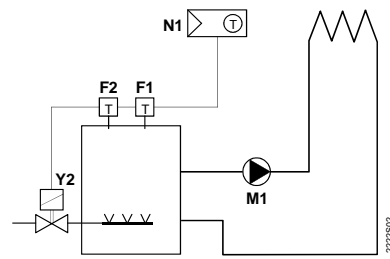

Room temperature controller with direct control of a gas-fired floor-standing boiler

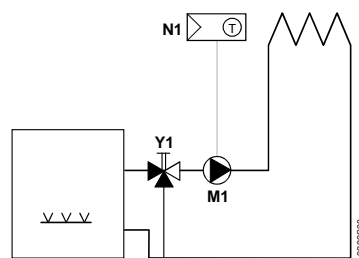

Room temperature controller with direct control of a heating circuit pump (precontrol by manual mixing valve)

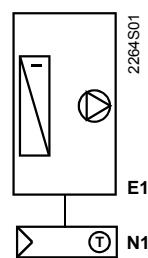

Room temperature controller with direct control of cooling equipment

F1 Thermal reset limit thermostat
 F2 Safety limit thermostat
 M1 Circulating pump

E1 Cooling equipment
 N1 Room temperature controller RDH10
 Y1 3-port valve with manual adjustment
 Y2 Magnetic valve

Dimensions

Room temperature controller

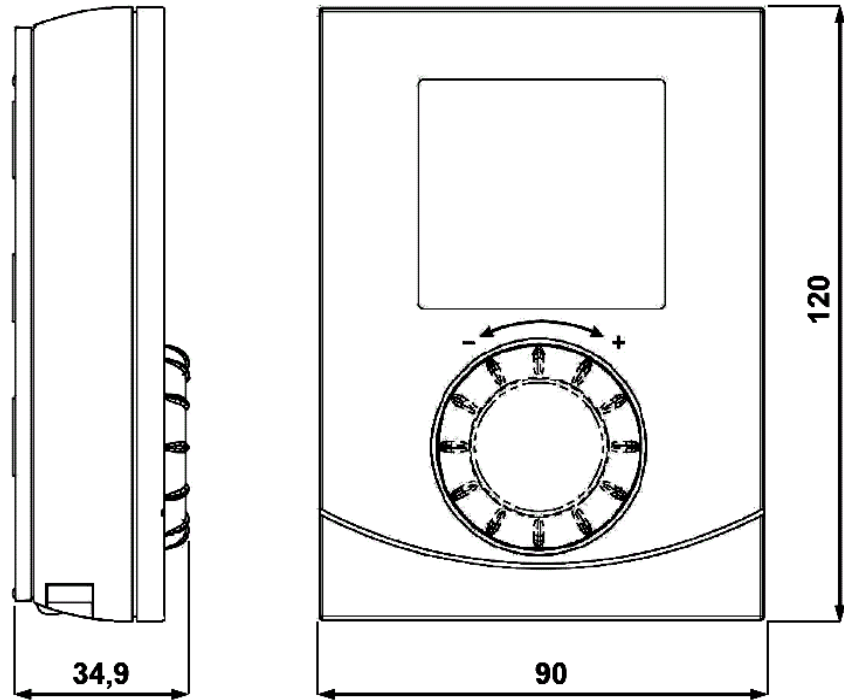

Baseplate

